

# ACTUATION SYSTEMS for PATIENT LIFTING APPLICATIONS

TiMOTION Provides Flexible,  
Customized Products, and Tailor-made Solutions

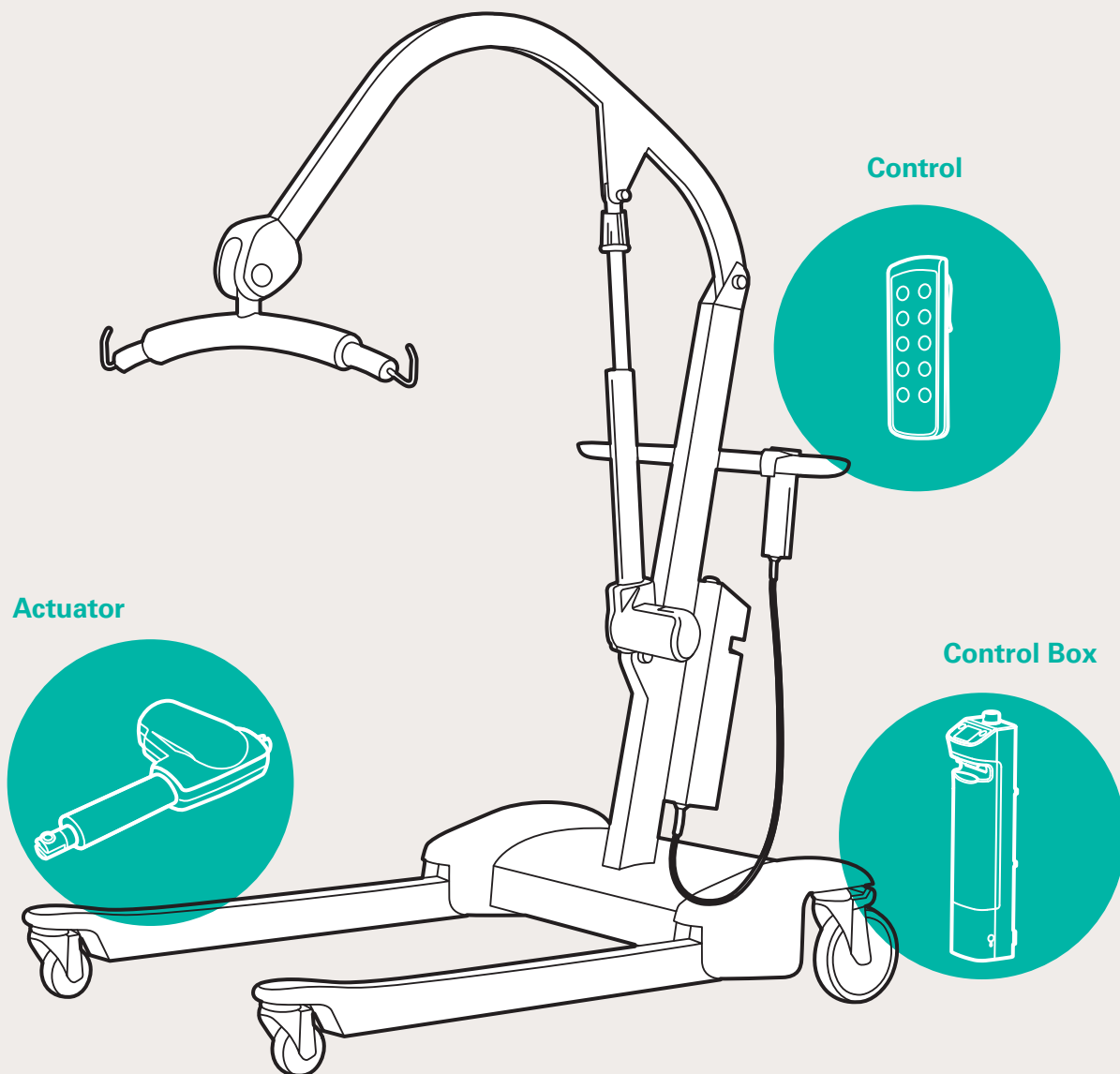

# AN INTELLIGENT ACTUATION SYSTEM FOR PATIENT LIFTS

TiMOTION created an optimal solution to meet specific patient needs and to ensure safe and comfortable transfers.

This system also provides a safe and efficient working environment for the caregivers.

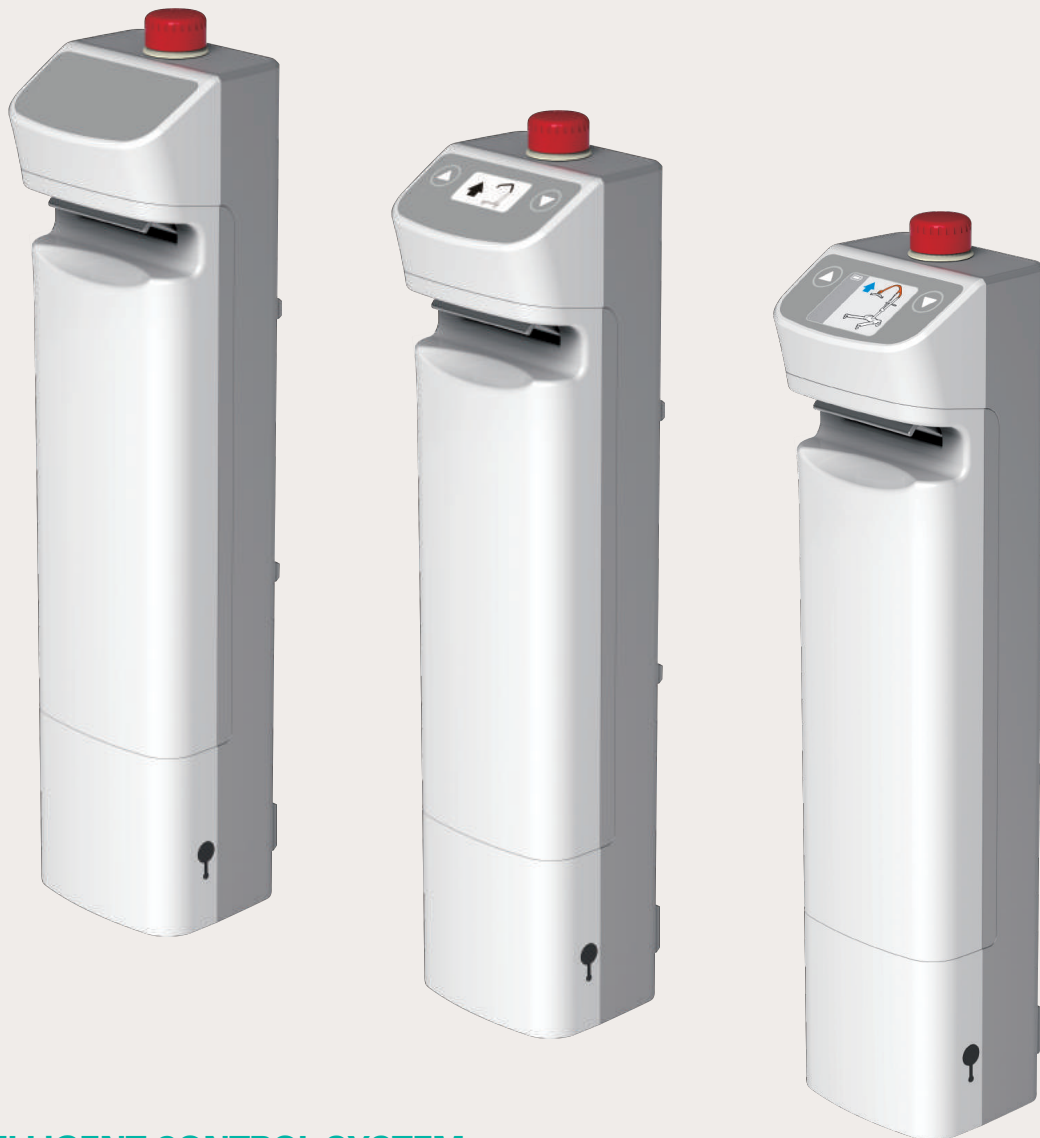

## **AN INTELLIGENT CONTROL SYSTEM TC12 SERIES**

- IP rating: IPX4
- EN 10535:2006, ETL(UL)60601-1, and EN60601-1 3<sup>rd</sup> edition compliant
- Multiple display options: without / black-white / color
- Includes detouchable battery pack
- With wall mount battery charger or battery charger dock
- Regular maintenance / overload alarm notification
- Alarm to indicate low battery capacity
- Easy installation

## Key Features of the UI on TC12\*

Note: here's an example of the TC12 with color-display



## Drawing

Standard Dimension (mm)

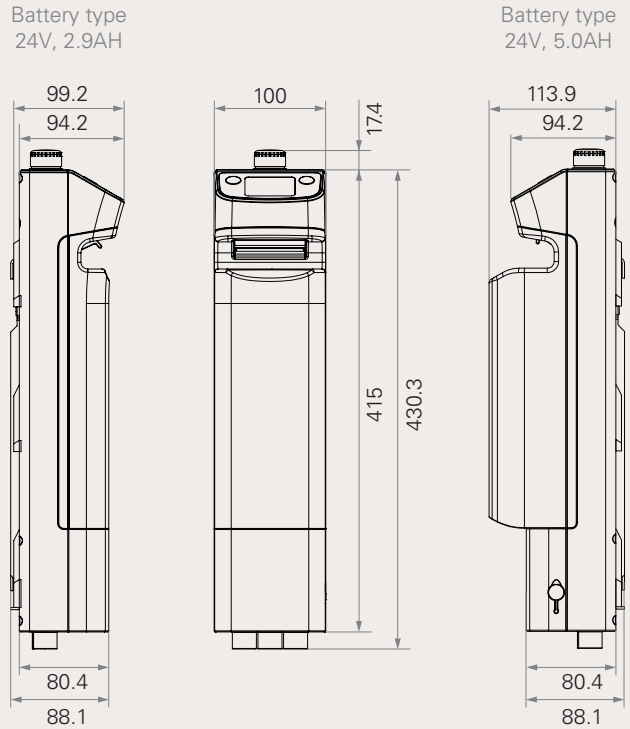

## Operation Status

Control open / close up / down and sling movements

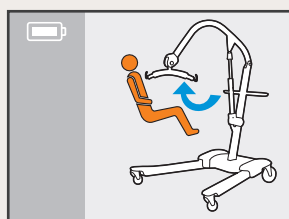
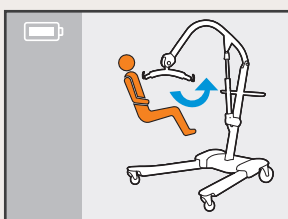
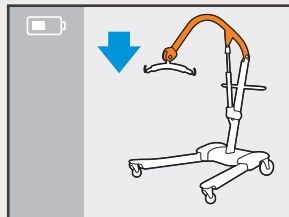
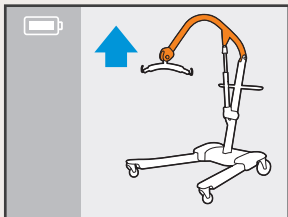
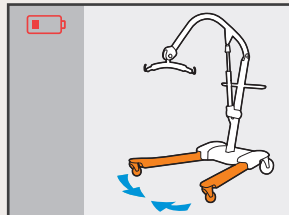
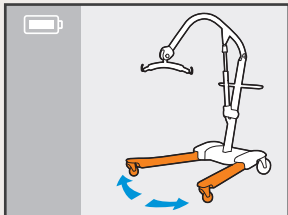

## Notification

Alarm for low battery capacity, overloading, and safety switch to prevent over extending

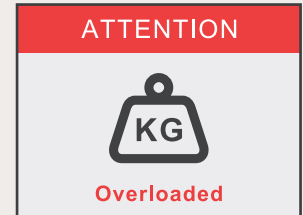

## Battery Status

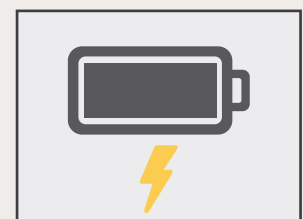
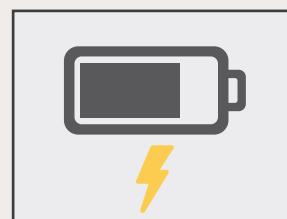
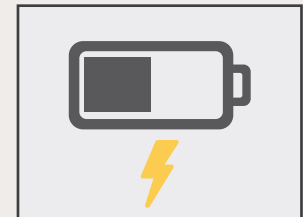
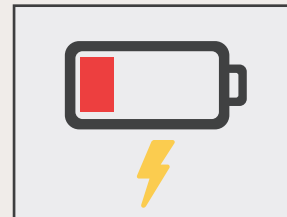

Note: for more detailed user guide information, please contact TiMOTION sales team.

## Solution Overview

Control box: TC12

Control: TH10

Actuators for lifting: TA12, TA23, or TA24

Actuators for leg adjustment / sling angle: TA7, TA16, or TA23

Accessories: TBC2\*

\*TBC2 Charging Cradle.

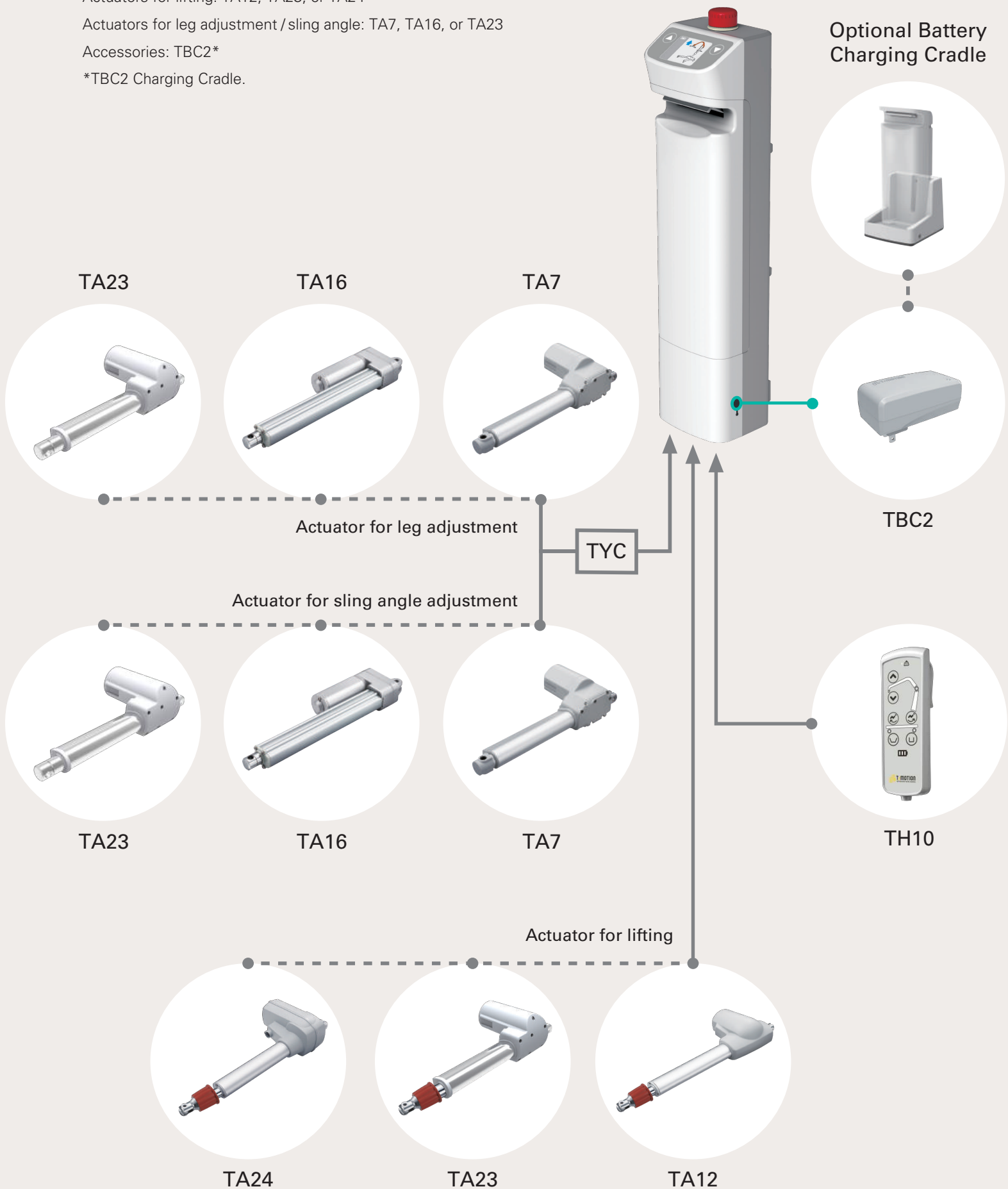

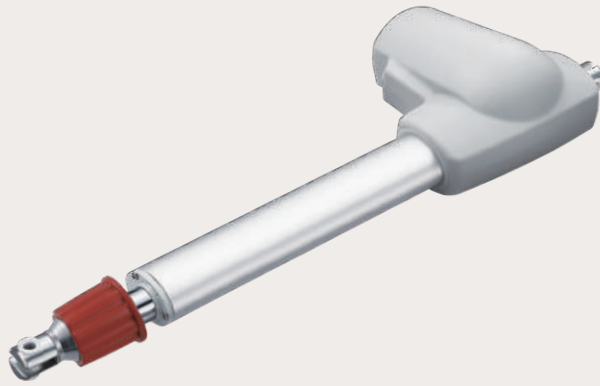

### ACTUATOR for LIFTING TA12 SERIES

- Load: 10,000 / 12,000N in push
- Protection class: IPX4
- Certificate: IEC 60601-1 compliant

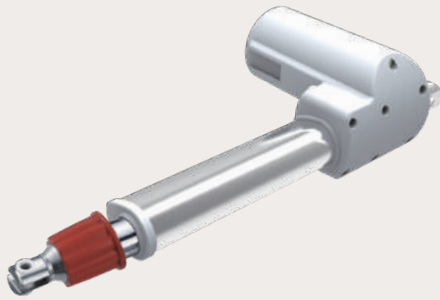

### ACTUATOR for LIFTING TA23 SERIES

- Load: 8,000N in push
- Protection class: IPX4
- Certificate: IEC 60601-1 compliant

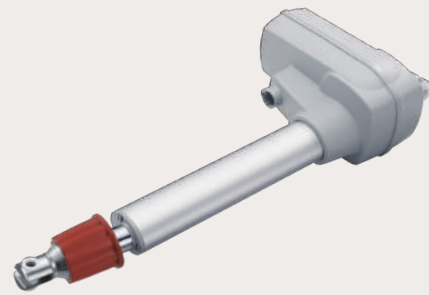

### ACTUATOR for LIFTING TA24 SERIES

- Load: 6,000N / 8,000N / 10,000N in push
- Protection class: IPX4



### OPTIONAL CHARGING CRADLE



### BATTERY CHARGER for TC12 TBC2 SERIES

- The TP7C must always be ordered separately when ordering TC12



### CONTROL TH10 SERIES

- Indicator lights show battery status
- Controls lifting and lowering
- Controls lower leg movement
- Alarm notifications for low battery capacity and overloading

- For single motor
- For two motors
- For three motors

## Installation Guide

1. Install the bracket on the hoist frame

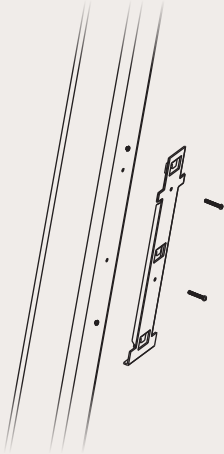

2. Install the TC12 on the bracket

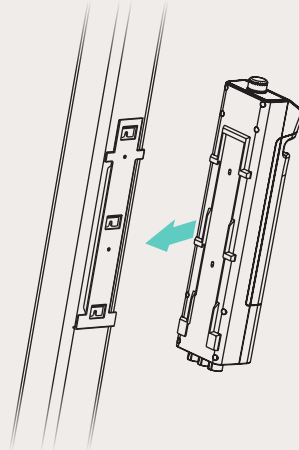

3. Make sure all fasteners are tightened properly

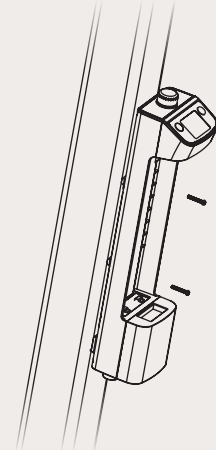

4. Install the battery

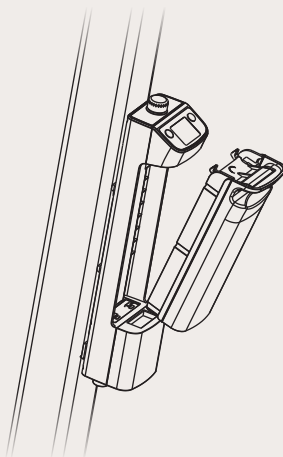

5. Installation is complete

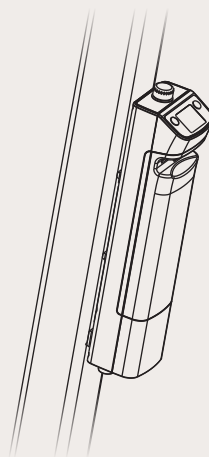

---

### Headquarters

TiMOTION Technology Co., Ltd.

Tel +886 2 2219 6633

Email sales.tw@timotion.com

### Dongguan

Tel +86 769 8706 2055

Email sales.tw@timotion.com

### Kunshan

Tel +86 512 5526 0735

Email sales.tw@timotion.com

### Japan

Tel 81 6 6713 1188

Email sales.jp@timotion.com

### Europe

Tel +33 (0)1 74 82 50 51

Email sales.eu@timotion.com

### Korea

Tel +82 31 745 1060

Email sales.kr@timotion.com

### USA

Toll Free (855) 235 1424

Email sales.us@timotion.com